

AEG

AUS ERFAHRUNG GUT

LAVATHERM T3

Ablufttrockner
Exhaust air dryer

Gebrauchsanweisung
Operating instructions

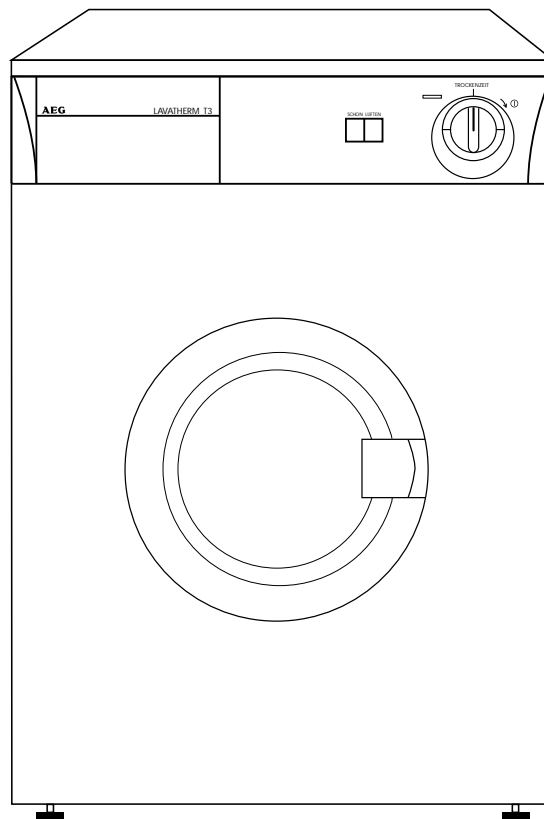

Dear customer,

Please read these operating instructions carefully and pay particular attention to the safety notes indicated in the first pages. We recommend that you keep this instruction booklet for future reference and pass it on to any future owners.



The warning triangle and/or the key words (Warning!, Caution!) emphasize information that is particularly important for your safety or correct functioning of the appliance.



This symbol guides you, step by step, in the operation of the appliance.



The information marked with this symbol provides additional instructions and practical tips on the use of the appliance.



Tips and information about economical and ecological use of the machine are marked with the clover symbol.

Should any problems arise, this booklet provides instructions on how to solve them by yourself; see section "Something not working?".

If this information is not sufficient, please contact our nearest Service centre (address and telephone numbers are indicated on the enclosed leaflet).

Printed on recycled paper.
People who think ecologically, act accordingly...

Contents

Safety instructions	25
General instructions	27
Discarding	28
Tips for environmental protection	29
The most important features of your appliance	30
Structure of the appliance	31
Front view	31
Rear view	31
Control panel	32
Programme selector	33
Programme selector as phase indicator	33
Before the first drying cycle	33
Brief operating instructions	34
Drying	35
Sort out the laundry	35
Open the door	35
Load the laundry	35
Select the drying programme	35
Remove or add laundry	36
End of drying cycle	36
Switch the tumble dryer off	36
Clean the filter	36
Programme charts	37
Brief summary of fabric information	38
Care symbols	38
Cleaning and care	39
Cleaning the door	39
Cleaning the drum	39
Cleaning the panel and the controls	39
Something not working?	40
Technical specifications	41
Electrical connection	41
Special accessory	41
Kit washing/drying column	41
Service	42



Safety instructions

The safety of AEG appliances complies with the industry standards and with legal requirements on the safety of appliances. However, as manufacturers, we feel it is our duty to provide the following safety notes.

General safety

- Repairs to the dryer must be carried out only by qualified personnel. Repairs carried out by inexperienced persons could cause serious danger. Contact our Service Centre or your AEG dealer.
- Before starting the appliance check that the rated voltage and the type of current indicated on the rating plate correspond to those which exist where the dryer is installed. The type of fuse is also indicated on the rating plate.
- Never start the appliance if the electrical supply cable is damaged or the control panel or worktop are so damaged that inner components can be reached.
- Unplug the appliance before carrying out any cleaning or maintenance operations.
- Never pull the power supply cable to remove the plug from the socket; always take hold of the plug itself.
- Do not lean on the open door, the appliance could turn over.
- Never spray the machine with a jet of water. Danger of electric shock!
- If the drying programme is interrupted in order to remove the laundry: the laundry and the drum could be very hot.

Child safety

- Children are often not aware of how dangerous electrical appliances can be. When the machine is working, they should be carefully supervised and not be allowed to play with the appliance - there is a risk that they could become trapped inside.
- The packaging components (e.g. plastic film, polystyrene) can be dangerous to children - danger of suffocation! Keep them out of children's reach.
- Make sure that children or pets do not climb into the drum.

Positioning and connection

- Follow the separate instructions for positioning and connection and, if necessary, take into consideration the advice of your local chimney sweep or of local authorities.
- Check that the appliance has not been damaged during transport. Never connect a damaged appliance! If this is the case, contact your dealer.
- The dryer must not be installed in a room where the temperature can fall below zero or higher than + 35°C.
- The dryer must be positioned horizontally.
- The dryer must not be positioned on a thick pile carpet as this would prevent air from circulating freely through the ventilation slots.
- If the appliance is installed near a gas, coal or electric heater, an insulating not-inflammable panel must be inserted between the dryer and the heater (size: 85x57.5 cm).
- The plug of the dryer must always be accessible.
- The dryer's exhaust must not be fed into a cooker hood, or a chimney or flue pipe designed to carry the exhaust from a fuel burning appliance.
- For correct ventilation of the room, avoid the formation of low pressure.
- A permanent connection to the mains power supply can only be carried out by a qualified electrician.

Proper use

- For safety reasons, the appliance must not be modified.
- This appliance is designed for domestic use only. If the dryer is used for any other purposes or is not used correctly, the manufacturer accepts no responsibility for any possible damage that might occur.
- Dry only items that have been washed with water. Never dry items that have been in contact with inflammable solvents (petrol, methylated spirits, dry cleaning fluid and the like). These are of a volatile nature and could cause an explosion or a fire.
- Items containing rubber foam or materials similar to rubber foam must not be dried in the appliance. Fire danger!

i General instructions

- Starched fabrics leave traces of starch in the drum, therefore they should not be dried in the appliance.
- If the load to be dried exceeds the maximum weight indicated, creasing may occur. For particularly delicate fabrics, the maximum load should not exceed 1.5 kg.
- For your information: 70 per cent of fabric wear is caused by wearing the garments, 20 percent by washing and only 10 percent by drying them in a tumble dryer. In your appliance, fluff accumulates in the filter. Only 0.03g fluff per Kilo will be lost by your laundry when being machine dried.



Discarding

Packaging materials

Dispose of your tumble dryer's packaging materials correctly. All materials are environmentally friendly and can be disposed of without any danger, or can be burnt in the refuse incinerator.

The plastic parts can be reused:

- The external plastic cover and the bags inside are made of polyethylene (>PE<).
- The padding is made of CFC free polystyrene foam (>PS<=).

Cartons are made of recycled paper and should be disposed of in paper collection containers.

Appliance



Warning! When the appliance is disposed of, pull the plug out of the socket, cut off the electrical supply cable and destroy the plug with the remaining cable. Disable the door catch in order to prevent children from becoming trapped inside while playing.

To dispose of the appliance correctly, contact the local body responsible for collection.



Tips for environmental protection

- During washing, try not to use fabric softeners!
If the laundry is machine dried, it will remain soft even without using fabric softeners.
- Shake out your laundry!
Shake out the laundry before putting it into the dryer in order to reduce the drying time and creasing.
- Spin the laundry properly before drying it!
As a general rule, the more the laundry is spun, the more economically your dryer works.
In the following table, indications on consumption are provided, according to the spin speed. The data refers to 5 kg of laundry that have to be store dried.

Spinning:			Drying cycle:	
Revolutions per minute	Residual dampness		Time required in minutes	Energy requirement in kWh
	in litres	in %		
800	3.5	70	93	3.5
1000	3.25	65	85	3.2
1200	3.0	60	80	3.0
1400	2.75	55	70	2.8

- Please observe the full load specifications!
The machine works more economically if it is fully loaded, as indicated in the programme charts.

The most important features of your appliance

- Select the correct drying programme!

Select the drying programme suited to the type and quantity of laundry, so that your dryer will work more economically. Some consumption values:

Type of laundry	Desired degree of dryness	Load in kg	Duration in minutes	Energy consumption in kWh
Cotton ¹	Store dry	5	93	3.5
Cotton ¹	Iron dry	5	74	2.7
Mixed fabrics ²	Store dry	2.0	48	0.9

1) previously spun at 800 rpm

2) previously spun at 650 rpm.

- HALF HEAT button: can only be used for loads up to 2 kg!
- Clean the fluff filter after each drying cycle!

The most important features of your appliance

- Time selection by means of programme selector
- HALF HEAT button for gentle drying of delicate cottons
- FRESH & COOL button for gentle drying of delicate fabrics

Structure of the appliance

Front view

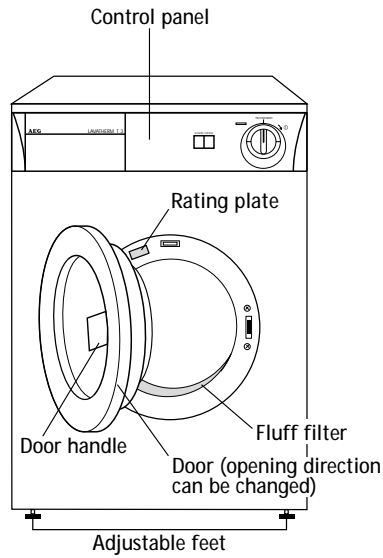

Rear view

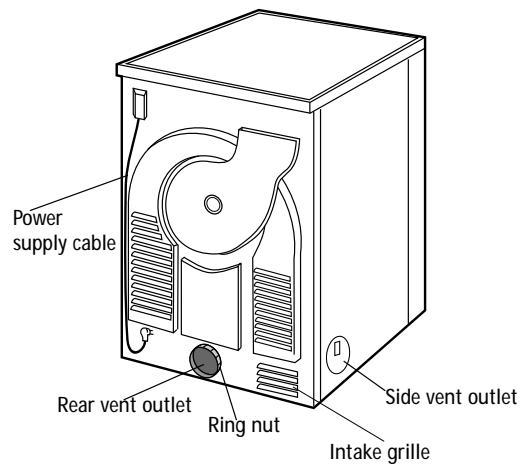

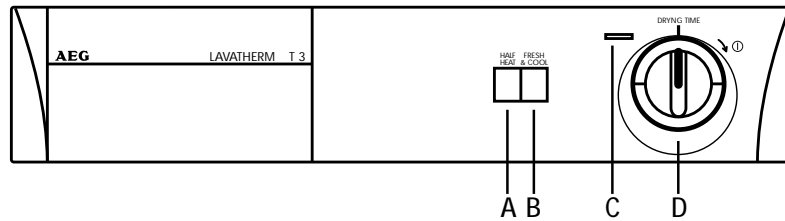

Control panel



- A HALF HEAT button: for delicate cottons.
- B FRESH & COOL button: for delicate fabrics.
- C Control light: comes on when the programme is selected.
- D Programme selector: to select the drying time.

Programme selector

- Time setting  120 MIN - 20 MIN: to select the required drying time, in minutes, for cottons.
- Time setting  80 MIN - 20 MIN: to select the required drying time, in minutes, for synthetics.
- COOLING Position : to smooth out creased garments with a cold air flow; slightly moisten the creased areas beforehand; duration: 8 minutes.
- OFF Position 0: in this position the dryer is switched off, the control light is not on.

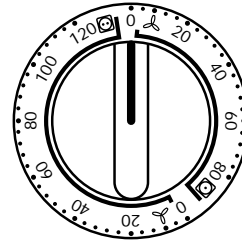

Programme selector as phase indicator

The programme selector acts as an indicator of the cycle phases, by turning clockwise until the end of the programme is reached.

Before the first drying cycle

-  Wipe the drum of the dryer with a damp cloth before performing the first drying cycle.

Brief operating instructions

- Spin the laundry as much as possible.
- Sort out the laundry.
- Put the laundry into the tumble dryer.
- If necessary, press the HALF HEAT or FRESH & COOL button.
- Select the drying time with the programme selector.

When the programme is in progress, the door can be opened in order to remove laundry or to add other items.

At the end of the programme:

- Switch off the tumble dryer.
- Remove the laundry.
- Clean the fluff filter.

Drying

Sort out the laundry

- To prevent bundling of laundry: close zips, button up pillow cases and duvet covers; tie any strings, such as apron strings.
- Empty pockets.
- Remove any metal parts (paper clips, safety pins, etc.).
- Turn garments made of double layer fabrics inside out (e. g. turn anoraks with cotton lining inside out), so that they will dry better.
- Shake out the laundry.

Open the door

- Pull the door handle outwards.

Load the laundry

Warning! When closing the door, do not trap any garments! The fabrics could get damaged.

- Put the prepared and shaken out laundry into the dryer.

Select the drying programme

- ☞ If necessary, press the HALF HEAT button or the FRESH & COOL button.

The selected programme will be performed with reduced heat or without heat.

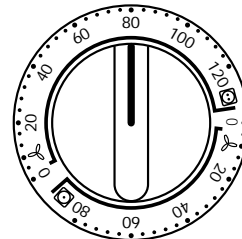

- ☞ Select the right drying time with the programme selector (see "programme chart").

The drying programme starts.

Remove or add laundry

It is possible to interrupt the drying cycle at any time in order to remove or add laundry.

- ☞ Open the door.
- Caution!** Laundry and drum can be hot.
- ☞ Remove or add laundry.
- ☞ Close the door to continue the drying cycle.

End of drying cycle

A **cooling phase** is performed before the end of the drying cycle: the heat is cut off during this phase. After the cooling phase, it is possible to remove the laundry from the dryer.

- ☞ Open the door and remove the laundry.

Switch the tumble dryer off

Pull out the plug.

Clean the filter

To ensure free circulation of air during the drying cycle, the fluff filter must be cleaned after each drying cycle, before removing the laundry. Use a damp cloth to do this.

- ☞ The fluff filter cannot be removed.

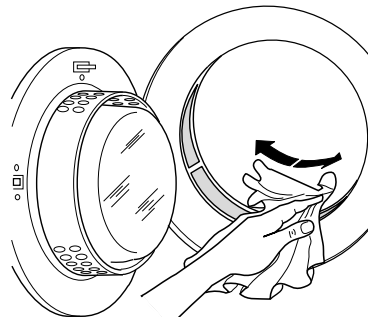

Programme charts

For laundry spun at 1000 revolutions per minute

Type of laundry	Examples of laundry/fabrics	Load in kg	Drying time	
			normal	HALF HEAT button
Thick or multilayer cottons which have to be thoroughly dried.	Towelling fabrics, bathrobes, towels.	5	85	-
		2	50	70
Thick or multilayer cottons which have to be ironed.	Bed linen, table cloths, dishtowels.	5	70	-
		2	35	60

For laundry spun at 650 revolutions per minute

Type of laundry	Examples of laundry/fabrics	Load in kg	Drying time	
			normal	HALF HEAT button
Delicate laundry, synthetics and mixed fabrics that do not need any treatment (e. g. ironing).	Delicate jumpers, shirts, bed linen, table cloths, underwear.	2	48	-

For laundry spun at 1200 revolutions per minute

Type of laundry	Examples of laundry/fabrics	Load in kg	Drying time	
			normal	HALF HEAT button
Thick or multilayer cottons which have to be thoroughly dried.	Towelling fabrics, bathrobes, towels.	5	80	-
		2	45	65
Thick or multilayer cottons which have to be ironed.	Bed linen, table cloths, dishtowels.	5	65	-
		2	30	55





COOLING PHASE

The laundry is treated with cold air for 8 minutes to smooth out any creasing.

Brief summary of fabric information

Care symbols

Check whether fabrics are suitable for tumble drying. One of the following symbols should appear on the care label:

-  Basically, this fabric can be tumble dried; however the manufacturer does not specify whether it can be dried with normal or low temperature.
-  Normal drying (normal temperature)
-  Gentle drying (low temperature)
-  Do not tumble dry

If none of these symbols is found:

Dry cottons, as well as mixed fabrics, at normal temperature. Press the HALF HEAT button when delicate cottons have to be dried.

It is advisable to take into consideration the care symbols on garment labels when buying them.

- Wool, eiderdowns
Do not dry any woollen items in the tumble dryer! They can felt!
Eiderdowns can be tumble dried only if the corresponding care symbol is present.
- Fabrics sensitive to high temperatures
Dry fabrics sensitive to high temperatures (such as acrylic or viscose) and items bearing the  care symbol using a drying time setting between 20 and 80 MIN or pressing the FRESH & COOL button.
- Tricot garments, knitwear
- Tricot garments and knitwear tend to shrink.
Do not overdry these items. High quality products are less likely to shrink.
- New coloured fabrics
Do not dry new coloured fabrics with light-coloured laundry. This could lead to discoloration!

Cleaning and care

Cleaning the door

- ☞ Clean the door regularly to remove any fluff.

Cleaning the drum

Warning! Do not clean the stainless steel drum with abrasive detergent or steel wool.

- ☞ Wipe the inside of the drum and the drum paddles with a standard household detergent (e.g. vinegar solution).

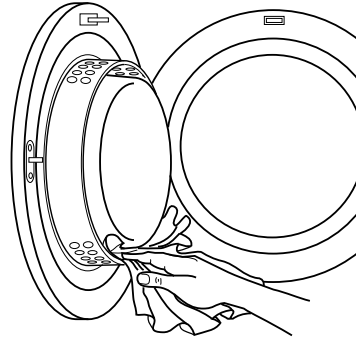

Cleaning the panel and the controls

Warning! Do not use household furniture polish or abrasive detergents.

- ☞ Wipe the panel and the controls with a damp cloth only. Use only warm water.

Something not working?

If a problem occurs, you can try to solve it yourself following the instructions below. If you call out an engineer when one of the following problems occurs, or to repair a fault due to incorrect use, the call-out will be charged even if requested within the guarantee period.

Problem	Possible cause
The dryer does not work.	The programme selector has not been set correctly.
	The plug is not connected.
	The main fuse has blown.
	The door is not properly closed.
Unsatisfactory drying results.	The programme selected is not correct.
	Clean the fluff filter.
	Follow the load indications.
The drying cycle is too long.	The laundry was not adequately spun.
	Clean the fluff filter.

If you cannot find any useful information in these operating instructions to solve your problem, please contact our nearest service centre.

Technical specifications

Height x Width x Depth	85x60x57 cm
Depth with the door open	93 cm
Height adjustment	6 mm
Empty weight	33 kg approx.
Load (according to the programme) (Different load sizes in some countries are due to different measuring methods)	max. 5 kg
Use	Domestic
Permissible ambient temperature	+5°C to +35°C

- CE** This appliance complies with the following EC directives:
- 73/23/EEC of 19/2/1973 "Low voltage directive"
 - 89/336/EEC of 3/5/1989 "EMC directive" including modification directive 92/31/EEC.

Electrical connection

Specifications concerning the power supply are indicated on the rating plate. The rated voltage and the type of current stated on the plate must correspond to those which exist where the dryer is installed. Also refer to the rating plate for the type of fuse required.

Permanent connection must be carried out only by a qualified engineer.

Special accessory

You can obtain the following special accessory through the AEG customer service organisation or from your dealer:

Kit Washing/drying column

With this kit you can combine your dryer with any LAVAMAT automatic washing machine to a washing and drying column. The appliances are stacked in space-economising manner in this arrangement, the washing machine at the bottom and the dryer at the top.

Service

In the chapter "Something not working?" some problems that can be solved by yourself are listed. Read this section in the event of problems. If you are not able to find a solution, contact the Service centre. It is close by and, if necessary, an engineer will soon be with you. (Addresses and telephone numbers are given on the enclosed form).

In all cases, set your speech before calling, in order to facilitate troubleshooting: the engineer will be able to decide whether a service visit is necessary.

Take note of the serial number (Ser. No.) and the product number (Prod. No.) indicated on the rating plate.

Ser. No.

Prod. No.

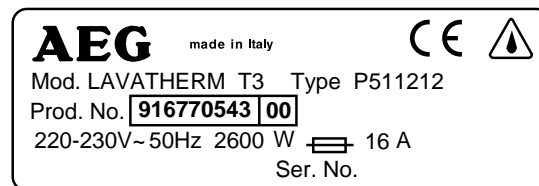

Try to specify, as precisely as possible:

- The symptoms of the fault.
- When the fault occurs.

When can a service visit be charged during the guarantee period?

- when it should have been possible to solve the problem by yourself, with the help of the troubleshooting chart (see section "Something not working?")
- when the engineer has to come out several times because he has not been given all the relevant information he needs and so, for example, has to fetch spare parts. Repeated trips can be avoided if you prepare your call to the Service centre as described above.

AEG Hausgeräte GmbH
Postfach 1036
D-90327 Nürnberg

<http://www.aeg.hausgeraete.de>

© Copyright by AEG

H125.995.031-02-0298